

Fast Recovery Bridge Rectifier

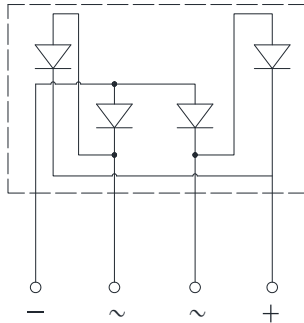
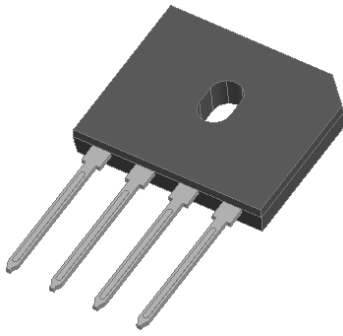

Features

- UL recognition, file #E230084
- Glass passivated chip junction
- Ideal for printed circuit boards
- High surge current capability
- Solder dip 275 °C max. 7 s, per JESD 22-B106

Typical Applications

General purpose use in AC/DC bridge full wave rectification for monitor, TV, printer, power supply, switching mode power supply, adapter, audio equipment, and home appliances applications.

Mechanical Data

- **Package:** GBU
Molding compound meets UL 94 V-0 flammability rating, RoHS-compliant
- **Terminals:** Tin plated leads, solderable per J-STD-002 and JESD22-B102
- **Polarity:** As marked on body

■Maximum Ratings (Ta=25°C Unless otherwise specified)

PARAMETER	SYMBOL	UNIT	RGBU610
Device marking code			RGBU610
Maximum Repetitive Peak Reverse Voltage	VRRM	V	1000
Maximum RMS Voltage	VRMS	V	700
Maximum DC blocking Voltage	VDC	V	1000
Average rectified output current @60Hz sine wave, R-load	IO	A	With heatsink Tc =118°C
			Without heatsink Ta =25°C
Forward Surge Current (Non-repetitive) @60Hz Half-sine wave, 1 cycle, Tj=25°C	IFSM	A	150
Forward Surge Current (Non-repetitive) @1ms, square wave, 1 cycle, Tj=25°C			300
Current squared time @1ms≤t≤8.3ms Tj=25°C, Rating of per diode	I ² t	A ² S	93.4
Storage temperature	Tstg	°C	-55 ~ +150
Junction temperature	Tj	°C	-55 ~ +150
Dielectric strength @ Terminals to case, AC 1 minute	Vdis	KV	2.5
Mounting torque @Recommend torque: 5kg·cm	Tor	kg·cm	8

■Electrical Characteristics (Ta=25°C Unless otherwise specified)

PARAMETER	SYMBOL	UNIT	TEST CONDITIONS	RGBU610
Maximum reverse recovery time	tr	ns	If=0.5A, Ir=1.0A, Ir=0.25A	500
Maximum instantaneous forward voltage drop per diode	VF	V	IFM=3.0A	1.3
Maximum DC reverse current at rated DC blocking voltage per diode	IR	μA	Tj =25°C	5
			Tj =125°C	100
Typical junction capacitance	Cj	pF	Measured at 1MHz and Applied Reverse Voltage of 4.0 V.D.C	38



RGBU610

■ Thermal Characteristics (T_a=25°C Unless otherwise specified)

PARAMETER		SYMBOL	UNIT	RGBU610
Thermal Resistance	Between junction and ambient, Without heatsink	R _{θJ-A}	°C/W	25.0
	Between junction and case, With heatsink	R _{θJ-C}		2.0

Note: Device mounted on 75mm x 45mm x 5.5mm Aluminum Plate Heatsink.

■ Ordering Information (Example)

PREFERRED P/N	PACKING CODE	UNIT WEIGHT(g)	MINIMUM PACKAGE(pcs)	INNER BOX QUANTITY(pcs)	OUTER CARTON QUANTITY(pcs)	DELIVERY MODE
RGBU610	B1	Approximate 3.96	20	1000	2000	TUBE

■ Characteristics (Typical)

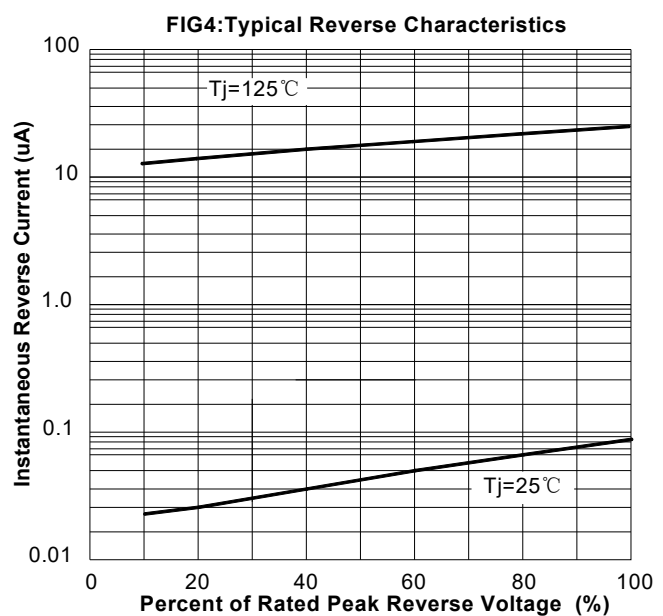
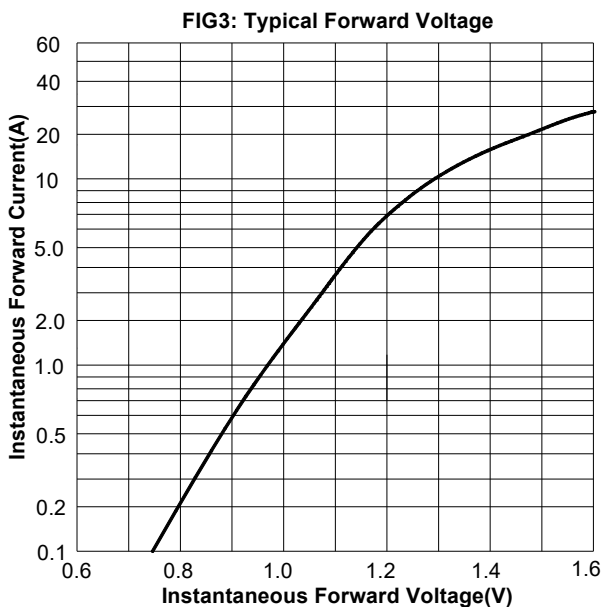
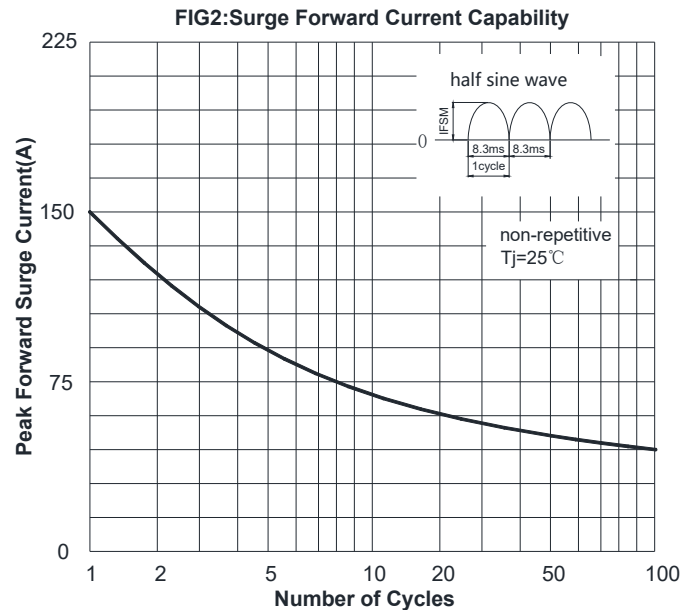
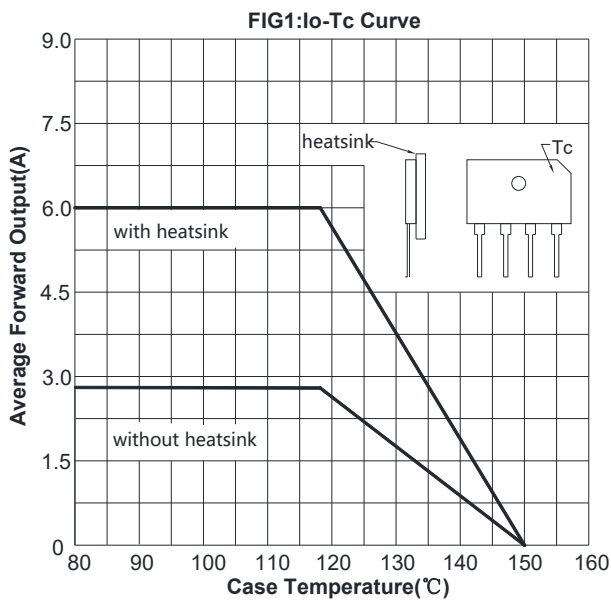
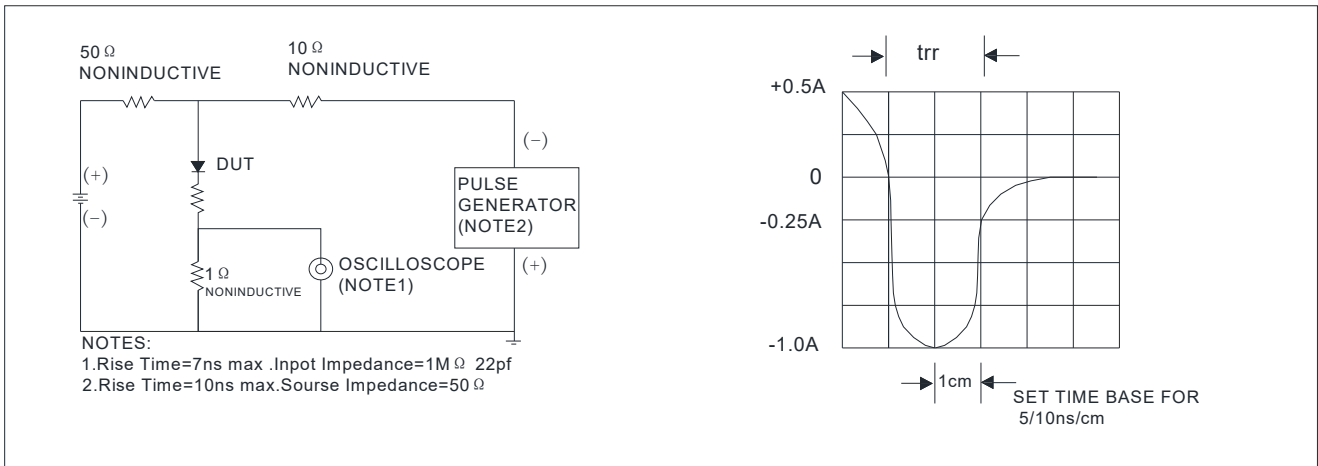
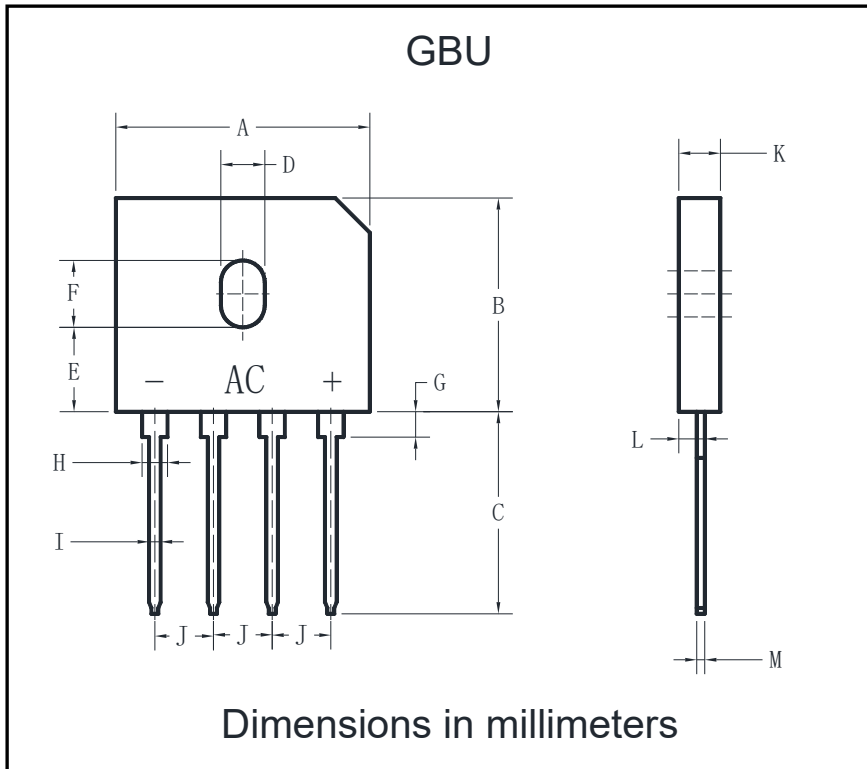

FIG.5: Diagram of circuit and Testing wave form of reverse recovery time



■ Outline Dimensions



GBU		
Dim	Min	Max
A	21.80	22.30
B	18.30	18.80
C	17.50	18.00
D	3.30	3.90
E	7.10	7.50
F	5.50	5.90
G	1.91	2.54
H	2.06	2.54
I	1.02	1.27
J	4.83	5.33
K	3.30	3.56
L	2.40	2.66
M	0.46	0.56



RGBU610

Disclaimer

The information presented in this document is for reference only. Yangzhou Yangjie Electronic Technology Co., Ltd. reserves the right to make changes without notice for the specification of the products displayed herein to improve reliability, function or design or otherwise.

The product listed herein is designed to be used with ordinary electronic equipment or devices, and not designed to be used with equipment or devices which require high level of reliability and the malfunction of which would directly endanger human life (such as medical instruments, transportation equipment, aerospace machinery, nuclear-reactor controllers, fuel controllers and other safety devices), Yangjie or anyone on its behalf, assumes no responsibility or liability for any damages resulting from such improper use of sale.

This publication supersedes & replaces all information previously supplied. For additional information, please visit our website [http:// www.21yangjie.com](http://www.21yangjie.com) , or consult your nearest Yangjie's sales office for further assistance.