

Small Signal Schottky Diode

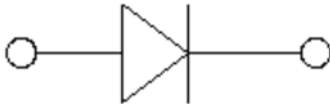

Features

- Moisture sensitivity level 1
- Reverse voltage: 70V
- Average forward current : 70mA

Application

- High frequency and low voltage rectifier

Mechanical data

- **Package:** SOD-123
- **Terminals:** Tin plated leads, solderable per J-STD-002 and JESD22-B102

■ Maximum Ratings (T_a=25°C Unless otherwise specified)

| Parameter | Symbol | Unit | Value |
|--|------------------|------|-------------|
| Device marking code | | | 73 |
| Repetitive peak reverse voltage | V _{RRM} | V | 70 |
| Forward current | I _F | mA | 70 |
| Non-repetitive surge peak forward current @ t=8.3ms half-sine wave | I _{FSM} | A | 0.1 |
| Non-repetitive surge peak forward current @ t=1ms square wave | | | 2 |
| Power dissipation | P _D | mW | 400 |
| Junction temperature | T _J | °C | -55 to +125 |
| Storage temperature | T _{STG} | °C | -55 to +150 |



■ Electrical Characteristics (T_a=25°C Unless otherwise specified)

| Parameter | Symbol | Unit | Conditions | Min | Typ | Max |
|-------------------------|-----------------|------|---|-----|-----|------|
| Breakdown voltage | V _R | V | I _R =10uA | 70 | | |
| Forward voltage | V _F | V | I _F =1mA | | | 0.41 |
| | | | I _F =15mA | | | 1.0 |
| Reverse leakage current | I _R | uA | V _R =50V | | | 0.2 |
| Junction capacitance | C _j | pF | V _R =1V, f =1MHZ | | | 2 |
| Reverse recovery time | T _{rr} | ns | I _F =I _R =10mA, I _{rr} =0.1*I _R , | | | 5 |

■ Thermal Characteristics

| Parameter | Symbol | Unit | Value |
|---|----------------------------------|------|-------|
| Thermal resistance, junction-to-ambient | R _{θJ-A} ⁽¹⁾ | °C/W | 250 |
| Thermal resistance, junction-to-case | R _{θJ-C} ⁽¹⁾ | °C/W | 200 |

Note:

(1) Thermal resistance from junction to ambient and from junction to case mounted on P.C.B. with 8mm*9mm copper pad areas



■ Characteristics

Fig 1: P_D - T_a Curve

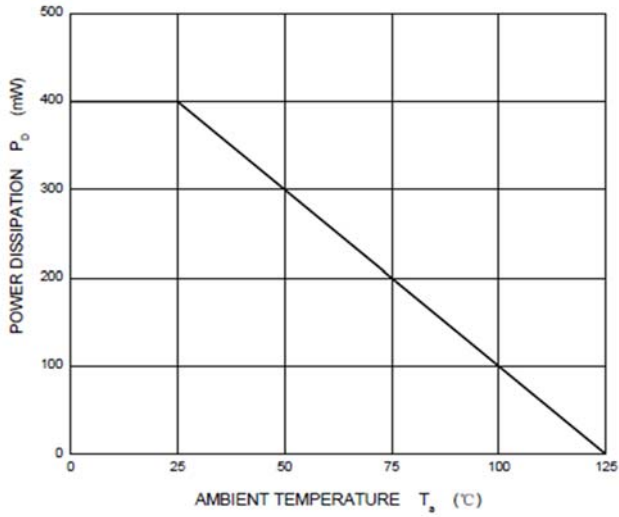

Fig 2: Capacitance Capability

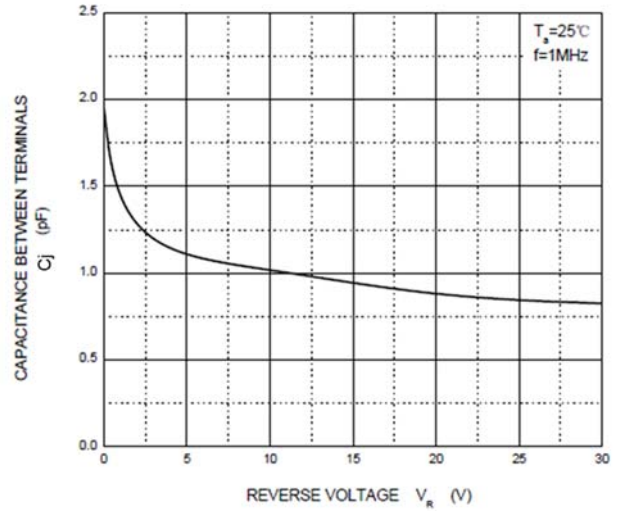

Fig 3: Typical Forward Characteristics

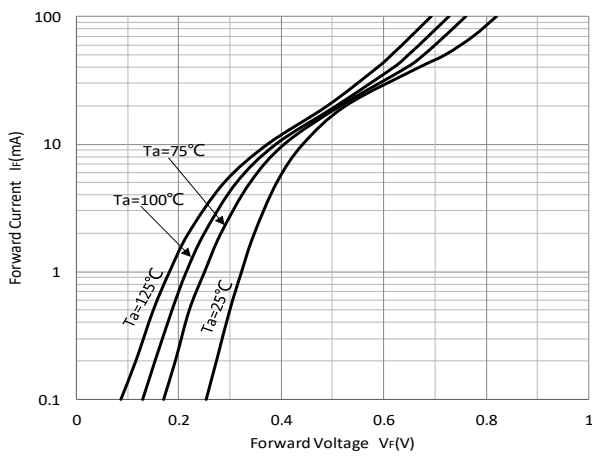
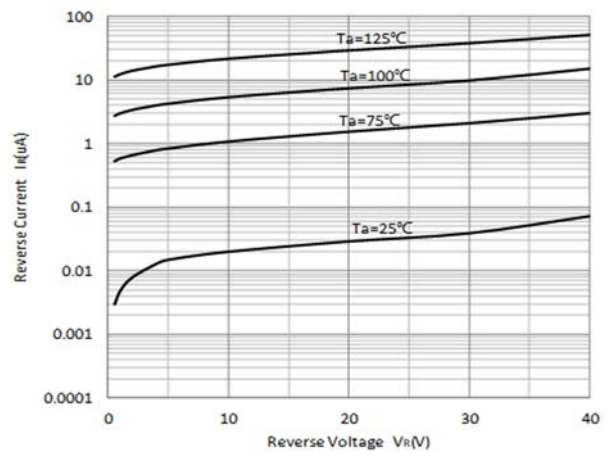

Fig 4: Typical Reverse Characteristics





BAS70W

RoHS
COMPLIANT

Ordering Information

| Preferred P/N | Packing code | Unit weight(g) | Minimum package(pcs) | Inner box quantity(pcs) | Outer carton quantity(pcs) | Delivery mode |
|---------------|--------------|-------------------|----------------------|-------------------------|----------------------------|---------------|
| BAS70W | F2 | Approximate 0.011 | 3000 | 30000 | 120000 | 7" reel |
| BAS70W | F3 | Approximate 0.011 | 10000 | / | 210000 | 13" reel |

Outline Dimensions

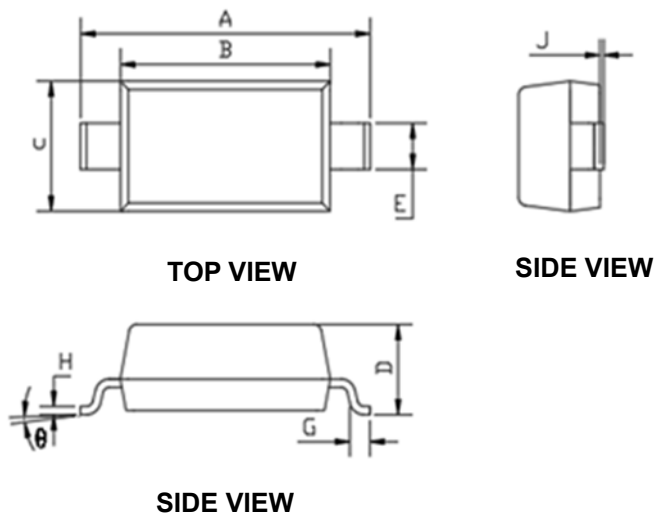

| DIMENSIONS | | | | |
|------------|--------|-------|-------|-------|
| DIM | INCHES | | MM | |
| | MIN | MAX | MIN | MAX |
| A | 0.140 | 0.152 | 3.550 | 3.850 |
| B | 0.100 | 0.112 | 2.550 | 2.850 |
| C | 0.055 | 0.071 | 1.400 | 1.800 |
| D | 0.037 | 0.053 | 0.950 | 1.350 |
| E | 0.020 | 0.028 | 0.510 | 0.710 |
| G | 0.006 | 0.018 | 0.150 | 0.450 |
| H | 0.003 | 0.010 | 0.080 | 0.250 |
| J | 0.000 | 0.006 | 0.000 | 0.150 |
| θ | 0 | 8° | 0 | 8° |

Suggested Pad Layout

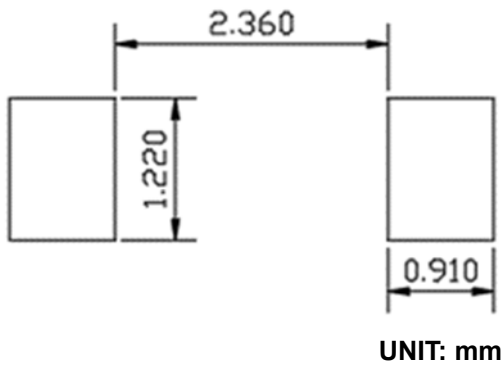



Disclaimer

The information presented in this document is for reference only. Yangzhou Yangjie Electronic Technology Co., Ltd. reserves the right to make changes without notice for the specification of the products displayed herein to improve reliability, function, or design or otherwise.

The product listed herein is designed to be used with ordinary electronic equipment or devices, and not designed to be used with equipment or devices which require high level of reliability and the malfunction of which would directly endanger human life (such as medical instruments, transportation equipment, aerospace machinery, nuclear-reactor controllers, fuel controllers and other safety devices), Yangjie or anyone on its behalf, assumes no responsibility or liability for any damages resulting from such improper use of sale.

This publication supersedes & replaces all information previously supplied. For additional information, please visit our website [http:// www.21yangjie.com](http://www.21yangjie.com) , or consult your nearest Yangjie's sales office for further assistance.