

## Switching Diode

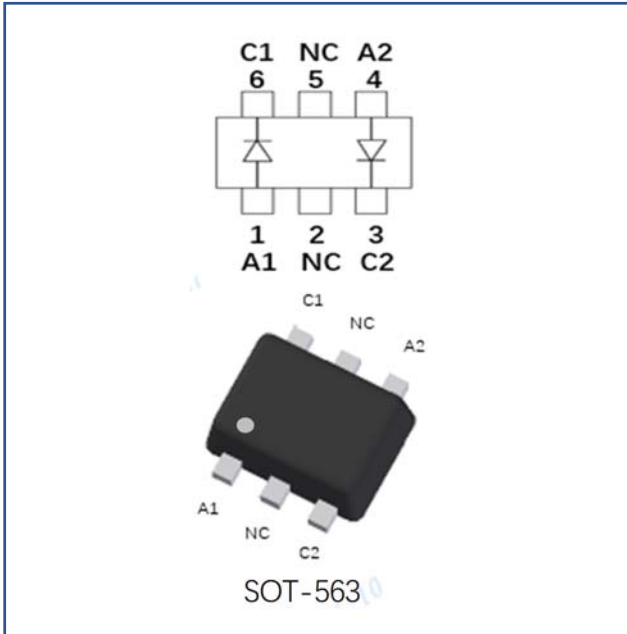

### Features

- Moisture sensitivity level 1
- Reverse voltage: 100V
- Average forward current : 200mA

### Application

- High frequency rectifier
- Signal switching

### Mechanical data

- **Package:** SOT-563
- **Terminals:** Tin plated leads, solderable per J-STD-002 and JESD22-B102

### ■ Maximum Ratings ( $T_a=25^\circ\text{C}$ Unless otherwise specified)

Item	Symbol	Unit	Value
Device marking code			KAM
Continuous reverse voltage	$V_R$	V	100
Forward continuous current	$I_F$	mA	200
Non-repetitive peak forward surge current @ $t=8.3\text{ms}$ half-sine wave	$I_{FSM}$	A	1.5
Non-repetitive surge peak forward current @ $t=1\text{ms}$ square wave			1.6
Power dissipation	$P_D$	mW	150
Junction temperature	$T_J$	$^\circ\text{C}$	-55 to +150
Storage temperature	$T_{STG}$	$^\circ\text{C}$	-55 to +150



# BAS16V

RoHS  
COMPLIANT

## ■ Electrical Characteristics (T<sub>a</sub>=25°C Unless otherwise specified)

Item	Symbol	Unit	Conditions	Min	Typ	Max
Reverse voltage	V <sub>R</sub>	V	I <sub>R</sub> =100uA	75		
Forward voltage	V <sub>F1</sub>	V	I <sub>F</sub> =1mA			0.715
	V <sub>F2</sub>	V	I <sub>F</sub> =10mA			0.855
	V <sub>F3</sub>	V	I <sub>F</sub> =50mA			1.0
	V <sub>F4</sub>	V	I <sub>F</sub> =150mA			1.25
Reverse current	I <sub>R</sub>	uA	V <sub>R</sub> =75V			2.5
Junction capacitance	C <sub>j</sub>	pF	f=1.0MHz, V <sub>R</sub> =0V			4
Reverse recovery time	T <sub>rr</sub>	ns	I <sub>F</sub> =I <sub>R</sub> =10mA, I <sub>tr</sub> =0.1*I <sub>R</sub> , R <sub>L</sub> =100Ω			4

## ■ Thermal Characteristics

Parameter	Symbol	Unit	Value
Thermal resistance, junction-to-ambient	R <sub>θJ-A</sub> <sup>(1)</sup>	°C/W	833
Thermal resistance, junction-to-case	R <sub>θJ-C</sub> <sup>(1)</sup>	°C/W	667

### Note:

(1) Thermal resistance from junction to ambient and from junction to lead mounted on P.C.B. with 25.4mm\*25.4mm copper pad areas



## ■ Characteristics

**Fig 1: P<sub>D</sub>-T<sub>a</sub> Curve**

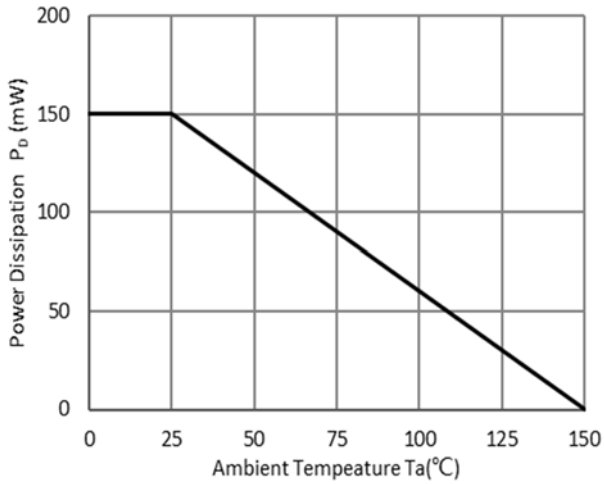

**Fig 2: Capacitance Capability**

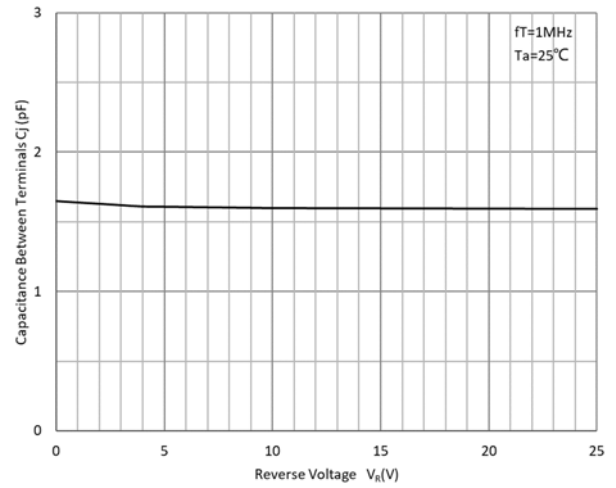

**Fig 3: Typical Forward Characteristics**

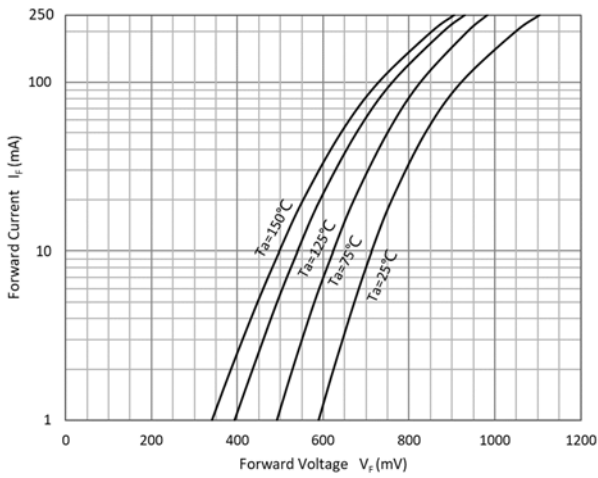

**Fig 4: Typical Reverse Characteristics**

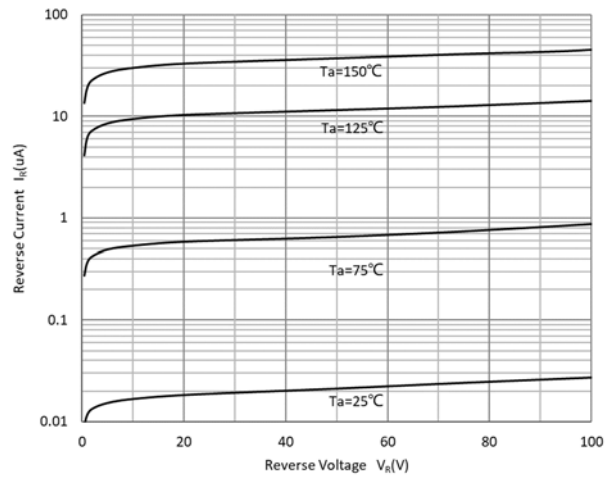



# BAS16V

RoHS  
COMPLIANT

## Ordering Information

Preferred P/N	Packing code	Unit weight(g)	Minimum package(pcs)	Inner box quantity(pcs)	Outer carton quantity(pcs)	Delivery mode
BAS16V	F2	Approximate 0.0035	3000	30000	120000	7" reel

## Outline Dimensions

SOT-563

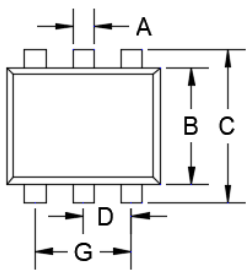

TOP VIEW

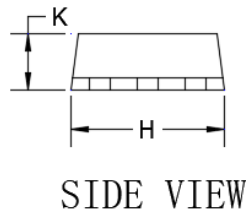

SIDE VIEW

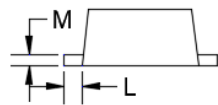

SIDE VIEW

DIM	DIMENSIONS			
	INCHES		MM	
	MIN	MAX	MIN	MAX
A	0.006	0.011	0.150	0.300
B	0.043	0.051	1.100	1.300
C	0.059	0.067	1.500	1.700
D	0.016	0.024	0.400	0.600
G	0.035	0.043	0.900	1.100
H	0.059	0.067	1.500	1.700
K	0.021	0.026	0.550	0.650
L	0.004	0.011	0.100	0.300
M	0.004	0.007	0.100	0.180

## Suggested Pad Layout

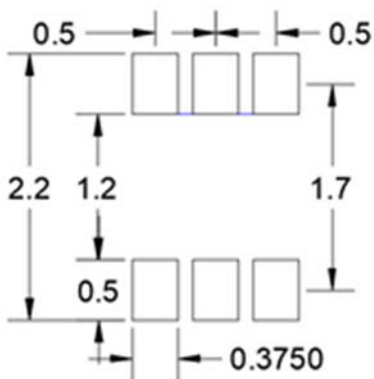

UNIT:mm



## Disclaimer

The information presented in this document is for reference only. Yangzhou Yangjie Electronic Technology Co., Ltd. reserves the right to make changes without notice for the specification of the products displayed herein to improve reliability, function, or design or otherwise.

The product listed herein is designed to be used with ordinary electronic equipment or devices, and not designed to be used with equipment or devices which require high level of reliability and the malfunction of which would directly endanger human life (such as medical instruments, transportation equipment, aerospace machinery, nuclear-reactor controllers, fuel controllers and other safety devices), Yangjie or anyone on its behalf, assumes no responsibility or liability for any damages resulting from such improper use of sale.

This publication supersedes & replaces all information previously supplied. For additional information, please visit our website [http:// www.21yangjie.com](http://www.21yangjie.com) , or consult your nearest Yangjie's sales office for further assistance.